

Cordset CEE-Prolink

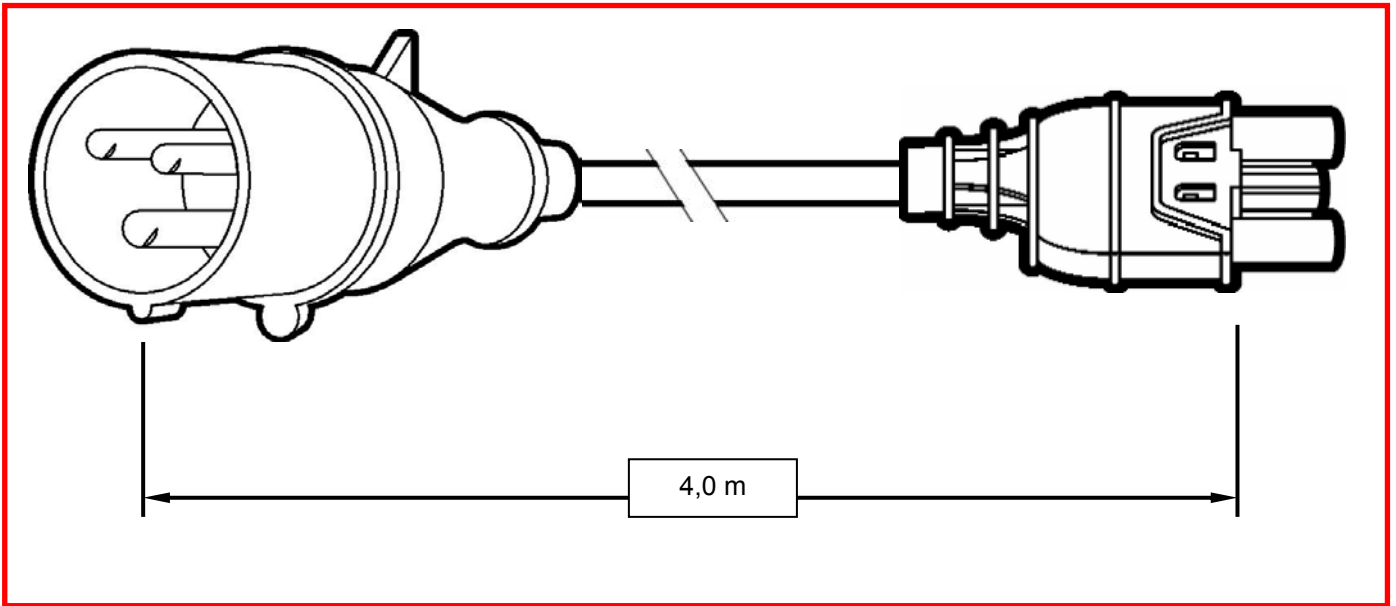

PRODUCT SPECIFICATION

▶ part number	1805-40
▶ current rating (A)	16
▶ voltage rating (VAC)	230
▶ temperature rating (°C)	-15 to +70
▶ plug type	IEC60309 3-pole Moulded, IP44
▶ plug colour	Blue
▶ plug style	Straight
▶	
▶ connector type	Prolink Female (Compatible Wieland GST18/3)
▶ connector colour	Light grey
▶ connector style	Straight
▶	
▶ cable type	H05VV-F 3G1,50mm ²
▶ cable outer diameter (mm)	8,5
▶ cable colour	Black

▶ cable length (m)	4,0
▶ cable size (mm ²)	1,50
▶ cable material	PVC
▶	
▶ weight (kg)	0.760
▶ packaging	
▶ plug approvals	VDE
▶ connector approvals	KEMA
▶	
▶	
▶ marking	
▶ Last modification	2009-04-09